

Catalogue 2016



LIQUID

eternoivica



eternoivica |









## LEGENDA MATERIALI MATERIAL INDEX

<b>I N O X</b>	Acciaio Inox Stainless Steel
<b>C U</b>	Rame Copper
<b>Z N</b>	Zinco Zinc
<b>M B P</b>	Membrana bituminosa polimerica Polymeric bituminous membrane
<b>G O M M A R U B B E R</b>	Gomma vulcanizzata Vulcanized rubber
<b>T P E</b>	Elastomero termoplastico (gomma termoplastica) Thermoplastic elastomer (ther- moplastic rubber)
<b>P V C</b>	Cloruro in polivinile Polyvinyl chloride
<b>T P O</b>	Poliolfine Polyolefin
<b>T P E F L A T</b>	Elastomero termoplastico (gomma termoplastica liscia) Thermoplastic elastomer (thermoplastic rubber flat)
<b>E C B</b>	Polimero etilene-bitumi Polymer ethylene-bitumen
<b>P P</b>	Polipropilene Polypropylene
<b>P E</b>	Polietilene Polyethylene

## LEGENDA APPLICAZIONI APPLICATIONS INDEX

	Applicazione a colla/freddo con pennello Glue/cold application with brush
	Applicazione a fiamma Torch-on application
	Applicazione aria calda Hot air application
	Applicazione membrana liquida, cemento bicomponente con rullo Liquid waterproofing, cementitious bicomponent application with roll
	Articoli commercializzati Traded items

## LEGENDA COMPATIBILITÀ PRODOTTI ETERNO E LIQUID "ETERNO" AND "LIQUID" PRODUCTS COMPATIBILITY INDEX

	Membrane impermeabilizzanti bitume polimero: elastomeriche, elastoplastomeriche, plastomeriche Bitumen-polymer waterproofing membranes: elastomeric, elastoplastomeric, plastomeric
	Membrane in gomma EPDM EPDM rubber membranes
	Membrane sintetiche in PVC PVC synthetic membranes
	Membrane sintetiche in TPO TPO synthetic membranes
	Membrane sintetiche in ECB e bituminosi in SBS ECB synthetic and SBS bituminous membranes
	Qualsiasi tipo di membrana impermeabile Any type of waterproofing membrane
	Bitume ossidato, guaina liquida a freddo, cemento bicomponente Oxidized bitumen, cold liquid membrane, two-component cement
	Resine poliuretatiche ed epossidiche Polyurethane and epoxy resins

NB.: LE MISURE INDICATE NEL PRESENTE CATALOGO  
SONO ESPRESSE IN MM, SALVO DIVERSE INDICAZIONI.  
NB.: ALL MEASURES IN THIS CATALOGUE ARE  
EXPRESSED IN MM, IF NOT OTHERWISE INDICATED.



L I Q U I D

INTRODUZIONE GENERALE INTRODUCTION	p.4
INTRODUZIONE LIQUID LIQUID INTRODUCTION	p.14
PRODOTTI PRODUCTS	p.16
Liquid telescopico TNT Liquid telescopic with non-woven sheet	p.16
Kit Liquid telescopico verticale e orizzontale in TNT Kit Liquid telescopic with non-woven sheet	p. 18
Liquid laterale telescopico TNT Liquid side telescopic wit non-woven sheet	p.20
Liquid verticale telescopico TNT Liquid straight telescopic with non-woven sheet	p.22
Liquid telescopico FV Liquid telescopic with fiberglass mesh	p.24
Kit Liquid telescopico verticale e orizzontale FV Kit Liquid telescopic with fiberglass mesh	p.26
Liquid laterale telescopico FV Liquid side telescopic with fiberglass mesh	p.28
Liquid verticale telescopico FV Liquid straight telescopic with fiberglass mesh	p.30
Esalatore per le impermeabilizzazioni liquide Vent pipe for Liquid waterproofing	p.32
Bocchettoni angolari Liquid per poggiofi Liquid angular drain for balconies	p.36
Canalette doccia Shower channel	p.40
ACCESSORI ACCESSORIES	p.46

Eterno Ivica è un'azienda che da oltre 60 anni opera nel mercato dell'edilizia producendo accessori e componenti destinati a molteplici settori, in ognuno dei quali l'azienda si distingue per l'elevato grado di specializzazione e innovazione delle soluzioni proposte.

L'ampia gamma dei prodotti, interamente progettata e prodotta in Italia, è articolata in 8 linee e comprende: supporti per pavimenti sopraelevati, sottostrutture da esterno per pavimenti in doghe, accessori per l'impermeabilizzazione di coperture piane con membrane liquide ed in rotolo, sistemi per la canalizzazione delle acque, attrezzature per la posa, silenziatori acustici e ventilazione degli ambienti, servizi e prodotti per l'isolamento acustico.

Eterno Ivica fa parte del gruppo Plastic Plus, con Italtronic e Plastic Planet. Fra le aziende del gruppo si sviluppano costanti sinergie sia in ambito produttivo che progettuale, volte a massimizzare i livelli di qualità dei prodotti, innovazione nello sviluppo, efficienza dei servizi. La sede del gruppo Eterno Ivica è ubicata a Padova su un'area di 10.000 mq, dei quali 6.000 coperti.

## SUPERIOR QUALITY FOR BUILDING



Eterno Ivica is a company that for over 60 years has worked in the building market producing accessories and components for many sectors, in each of which the company is renowned for its high degree of specialization and innovation of the proposed solutions.

The wide range of products, designed and produced entirely in Italy, is divided into 8 lines and includes: support for raised flooring, substructures for outdoor decking, accessories for flat roofs waterproofing and liquid systems for sewage water, equipment for the installation, acoustic silencers and ventilation of rooms, services and products for soundproofing.

Eterno Ivica is part of the Plastic Plus Group, with Italtronic and Plastic Planet. Constant synergies have developed among the companies in the group both in the production as well as the project, aimed at maximizing the quality levels of products, innovation in the development, efficiency of service. The headquarters of the Eterno Ivica Group are located in Padova on an area of 10,000 square meters, of which 6,000 are covered.



PEDESTAL



WOODTECH

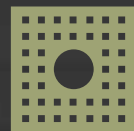

ETERNO



LIQUID



MASTER



MONDIAL



VENT



ACUSTICA

eterndivica

# LA NOSTRA STORIA

## OUR HISTORY



1955

### DAL 1955 FONDAMENTA SOLIDE

L'inizio di tutto è IVICA, che vuol dire Industria Veneta Idrofughi Catrami ed Affini. Ora l'attività aziendale comprende altri settori dell'edilizia, con la stessa voglia di essere specialisti assoluti. Sempre all'avanguardia in ogni specifica applicazione.

### SINCE 1955 SOLID FOUNDATIONS

It all began with IVICA, which stands for "Industria Veneta Idrofughi Catrami ed Affini" (Venitian Industry Tar waterproofing and Allied Products). Now company activities include other building sectors, and we still focus on being absolute specialists. Always on the cutting edge with each specific application.

1955

### NASCE I.V.I.C.A INDUSTRIA VENETA IDROFUGHI CATRAMI ED AFFINI

di Favero Ruggero "Industria Veneta Idrofughi Catrami ed Affini".

### THE BIRTH OF I.V.I.C.A VENITIAN INDUSTRY TAR WATERPROOFING AND ALLIED PRODUCTS

"Industria Veneta Idrofughi Catrami ed Affini" (Venitian Industry Tar waterproofing and Allied Products) by Favero Ruggero.

1972



### VIENE DEPOSITATO IL BREVETTO DEL BOCCHETTONE "ETERNO"

primo bocchettone di scarico per acque pluviali totalmente realizzato in gomma.

### THE PATENT IS FILED FOR THE "ETERNO" DRAIN

the first roof drain for rainwater entirely made of rubber.





**eterno·ivica**

1973

### NASCE LA SOCIETÀ ETERNO S.A.S.

che si dedicherà alla produzione di  
“accessori per manti impermeabili”.

### THE COMPANY ETERNO S.A.S. WAS FOUNDED

dedicated to producing “accessories  
for waterproof membranes”.

**“eterno”**



1980

### VIENE COSTITUITA ETERNO IVICA S.P.A.

dalla fusione delle due  
precedenti società.

### ETERNO IVICA S.P.A. WAS ESTABLISHED

by merging the former  
two companies.

1988

### IL MAXISOSTEGNO

Viene prodotto e presentato per la  
prima volta in Italia un supporto per  
pavimentazioni sopraelevate esterne,  
regolabile in altezza.

### THE MAXISOSTEGNO

A height-adjustable support system for  
external raised paving was produced and  
presented for the first time in Italy.



# LA NOSTRA STORIA

## OUR HISTORY

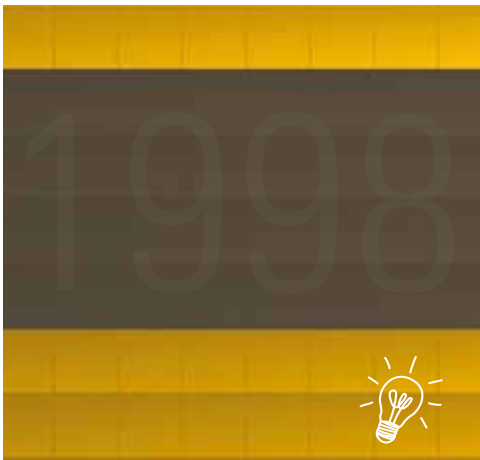

### VIENE DEPOSITATO IL BREVETTO DEL "BOCCHETTONE GENIUS"

Primo bocchettone di scarico per acque pluviali con "flangia forata".

### THE PATENT WAS FILED FOR THE "GENIUS" DRAIN

The first roof drain for rainwater with a "perforated flange".

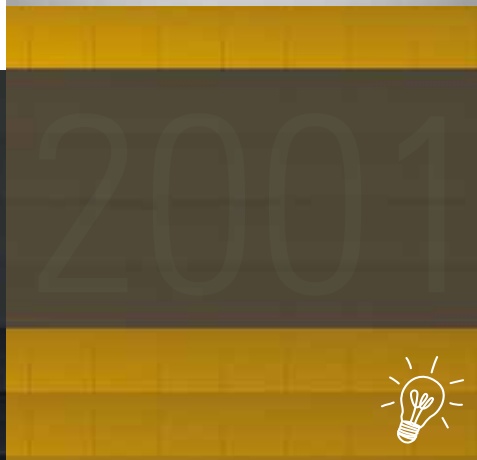

### VIENE DEPOSITATO IL BREVETTO SUPPORTO AUTOLIVELLANTE

Viene depositato il brevetto del supporto Eterno, primo e unico supporto per pavimentazioni sopraelevate esterne, regolabile in altezza, con testa basculante e autolivellante.

### THE PATENT WAS FILED FOR THE SELF-LEVELING SUPPORT

The patent was filed for the first original height-adjustable support for external raised paving, with a self-leveling head.



### NASCE IL GRUPPO PLASTIC PLUS

costituito da Eterno Ivica, Italtronic e Plastic Planet, con lo scopo di condividere esperienze e conoscenze, al fine di creare importanti sinergie a livello organizzativo.

### PLASTIC PLUS GROUP WAS ESTABLISHED

Eterno Ivica, Italtronic and Plastic Planet merged in order to share experiences and know-how and create important organizational synergies.





2003

### COSTRUZIONE DELLA NUOVA SEDE

in Via Austria, nella Zona Industriale di Padova.

### NEW HEADQUARTERS WERE BUILT

in Via Austria, in the industrial area of Padua.

2009



### VIENE DEPOSITATO IL BREVETTO TESTA SUPPORTO (PP+GOMMA)

viene depositato il brevetto del primo e unico supporto per pavimentazioni sopraelevate esterne, con la testa in bi-materiale (PP + gomma).

### THE PATENT WAS FILED FOR THE HEAD SUPPORT (PP+RUBBER)

The patent was filed for the first original support for external raised paving, with bi-component PP+rubber head.



2010

### NASCE LA LINEA NEW MAXI

Si rinnova la storica linea di supporti regolabili in altezza "Maxisostegno" con la nuova e moderna linea "New Maxi".

### THE NEW MAXI LINE WAS CREATED

The historic line of height adjustable supports "Maxisostegno" is renewed with the new and modern line "New Maxi".



## LA NOSTRA STORIA

## OUR HISTORY



2011

### NASCE LA LINEA LIQUID

Nasce l'innovativa linea di bocchettoni di scarico "LIQUID", appositamente studiata per l'applicazione con guaine liquide e resine mono/bicomponenti.

### THE LIQUID LINE WAS CREATED

The innovative "LIQUID" roof drain line was created, specifically designed for application with liquid membranes and mono/bi-component resins.

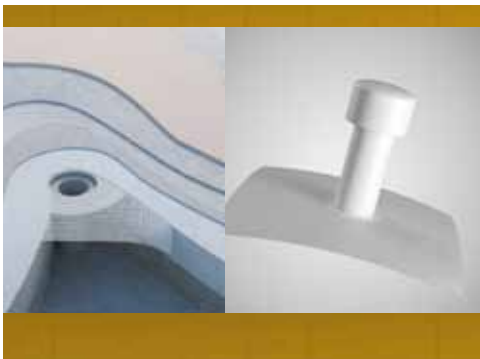

2013

### NASCE LA NUOVA LINEA ACUSTICA

È di quest'anno un importante investimento nel settore dell'isolamento acustico degli edifici, con la creazione e produzione della nuova linea di prodotti "Acustica".

### THE NEW "ACUSTIC" LINE WAS CREATED

This year important investment has been made in the field of sound insulation for buildings, with the creation and production of a new line of "Acustic" products.

2014

### ACQUISTATA STORICA SEDE ETERNO IVICA

in Via Prima Strada 20 a Padova la quale sarà oggetto di totale rifacimento.

### ACQUIRED ETERNO IVICA'S HISTORICAL HEADQUARTERS

Located in Prima Strada str. 20, Padua, and will be totally renovated.





2015



**VIENE DEPOSITATO  
IL BREVETTO DEL TXT**

primo prodotto acustico  
interamente riciclato e riciclabile.

**THE PATENT WAS FILED  
FOR THE TXT**

the first entirely recycled and  
recyclable soundproofing product.



2016



**ACQUISTO SOCIETÀ  
DANI SYSTEM E MARCHIO  
RUMOR BLOCK**

ACQUIRED DANI SYSTEM  
COMPANY AND THE RUMOR  
BLOCK BRAND

**VIENE DEPOSITATO  
IL BREVETTO STAR.T**

L'unico supporto regolabile in altezza  
al mondo in grado di sopraelevare da  
8 a 15 mm.

**THE PATENT WAS FILED  
FOR THE STAR.T**

The only support in the world  
adjustable from 8 to 15 mm.



## UN VIAGGIO NELLA QUALITÀ A 360°

## A JOURNEY IN QUALITY AT 360°



L'obiettivo primario di Eterno Ivica è garantire la massima qualità, affidabilità e sicurezza. L'impegno rivolto al conseguimento della qualità e al miglioramento continuo, il controllo costante sulle materie prime e i prodotti finiti sottoposti a specifici test, l'attenzione alla qualità dei processi e all'orientamento verso il cliente sono dimostrati dalla Certificazione ISO 9001:2008. Eterno Ivica ha inoltre conseguito la Certificazione ISO 14001:2008 a dimostrazione del rispetto di tutti i requisiti normativi rilevanti per l'ambiente, l'ottimizzazione dei consumi energetici, l'utilizzo di materie prime non inquinanti e la gestione ottimale dello smaltimento dei rifiuti. Infine la Certificazione SA 8000 premia le politiche etiche orientate al rispetto dei diritti sociali in tutta la filiera produttiva.

The primary goal of Eterno Ivica is to ensure the highest quality, reliability and safety. The efforts aimed at achieving quality and continuous improvement, constant control on raw materials and finished products undergoing specific tests, attention to the quality of processes and the orientation towards the client are proven by the ISO Certification 9001: 2008. Eterno Ivica has also obtained the ISO 14001: 2008 certification demonstrating compliance with all regulatory requirements relevant to the environment, the optimization of energy consumption, the use of raw materials not polluting and optimal management of waste disposal. Finally, the SA 8000 Certification rewards ethical policies oriented with respect for social rights in the entire production chain.

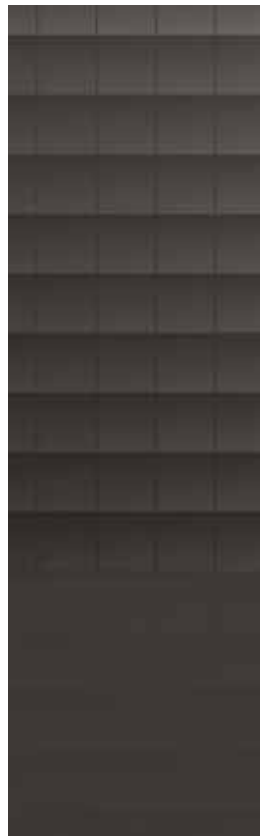





100% ETERNO IVICA,  
100% MADE IN ITALY,  
100% RICICLABILE

Tutti i prodotti Eterno Ivica sono progettati e interamente realizzati in Italia. Lo stile, il design, il gusto, la cura del dettaglio e l'eccellenza italiana contraddistinguono i nostri sistemi, distribuiti attraverso una rete di 30 distributori esclusivi e apprezzati in tutto il mondo.

L'intera produzione di Eterno Ivica è svolta internamente all'azienda, mediante 13 presse ad iniezione fino a 550 tonnellate, che lavorano a ciclo continuo, 6 giorni su 7. Il ciclo produttivo è completo, i prodotti escono pronti per la consegna.

100% ETERNO IVICA,  
100% MADE IN ITALY,  
100% RECYCLABLE

All Eterno Ivica products are designed and manufactured entirely in Italy. Style, design, taste, attention to detail and Italian excellence distinguish our systems, distributed through a network of 30 exclusive distributors and appreciated throughout the world.

The entire production of Eterno Ivica is performed in-house, using 13 injection molding machines up to 550 tons, which work around the clock, six days a week.

The production cycle is complete, the products come out ready for delivery. Attention to the environment by the company translates into concrete results.



## NOVITÀ CHE CAMBIANO IL CORSO DELL'ACQUA

## INNOVATIONS THAT CHANGE THE COURSE... OF WATER!

La Linea Liquid, grazie al processo di termofusione tra il fazzoletto e la flangia del chiusino, rappresenta oggi il sistema ideale per eseguire ad arte la posa degli accessori utilizzati per il deflusso delle acque, con risparmio di tempo ed evitando il pericolo di infiltrazioni in corrispondenza degli scarichi. Disponibile in due versioni: rete in fibra di vetro "FV" e tessuto non tessuto "TNT". Dotata di cinque diametri verticali, tre orizzontali, un esalatore, due linee di canalette e uno scarico per poggiolo, la Gamma Liquid si adatta a tutti i pacchetti impermeabilizzanti e isolanti. La Griglia con Telaio, esclusivamente in acciaio inox, è sinonimo di eleganza e robustezza. La Valvola anti intrusione, oltre a garantire un efficace blocco ai vari insetti che abitano le tubature, limita i cattivi odori di risalita. La Prolunga intagliabile permette di gestire i vari spessori dei pacchetti isolanti.

Thanks to the thermal fusion between the sheet and the cover flange, the Liquid Line has become the ideal system for installing water drainage accessories, offering significant time savings and eliminating the risk of leaks forming around the drains. The system is available in two versions: the FV version with fiberglass mesh, and the TNT version with non-woven fabric. Featuring five vertical, three horizontal diameters and an angular drain for balconies, the Liquid range can be adapted for use with any waterproofing and insulating package. The Grille and Frame, manufactured exclusively in stainless steel, features an elegant yet extremely robust design. In addition to preventing the backflow of unpleasant odours, the anti-odour plug also serves to block any unwelcome guests who may be inhabiting the pipes. The special Extension allows for the management of the various insulation package thicknesses.



L I Q U I D





LA PERFEZIONE  
È ANCHE QUESTIONE  
DI DETTAGLI

PERFECTION  
IS IN THE DETAILS



LIQUID  
TELESCOPICO TNT

LIQUID TELESCOPIC  
WITH NON-WOVEN  
SHEET

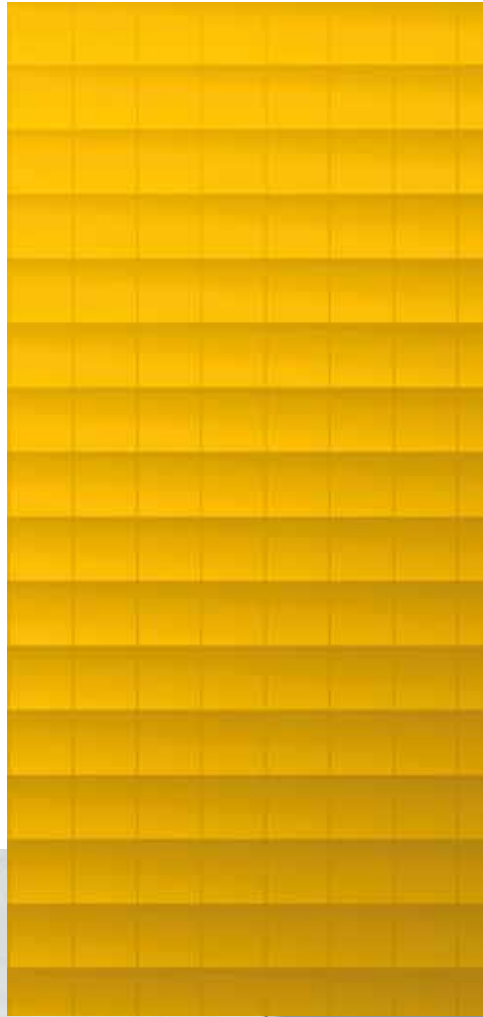



Liquid è la serie di accessori compatibili con tutti i tipi di impermeabilizzazioni liquide e i cementi bicomponenti.

È l'unico sistema di scarichi capace di assicurare l'assoluta continuità tra l'impermeabilizzazione e gli accessori per la canalizzazione dell'acqua: grazie al processo di termo-fusione tra il fazzoletto in tessuto non tessuto o in fibra di vetro e la flangia del chiusino evita il pericolo di infiltrazioni in corrispondenza degli scarichi. Composta da bocchettoni, esalatori e canalette, la gamma di prodotti è pensata per terrazze, balconi, docce, e permette una significativa riduzione del tempo di posa.

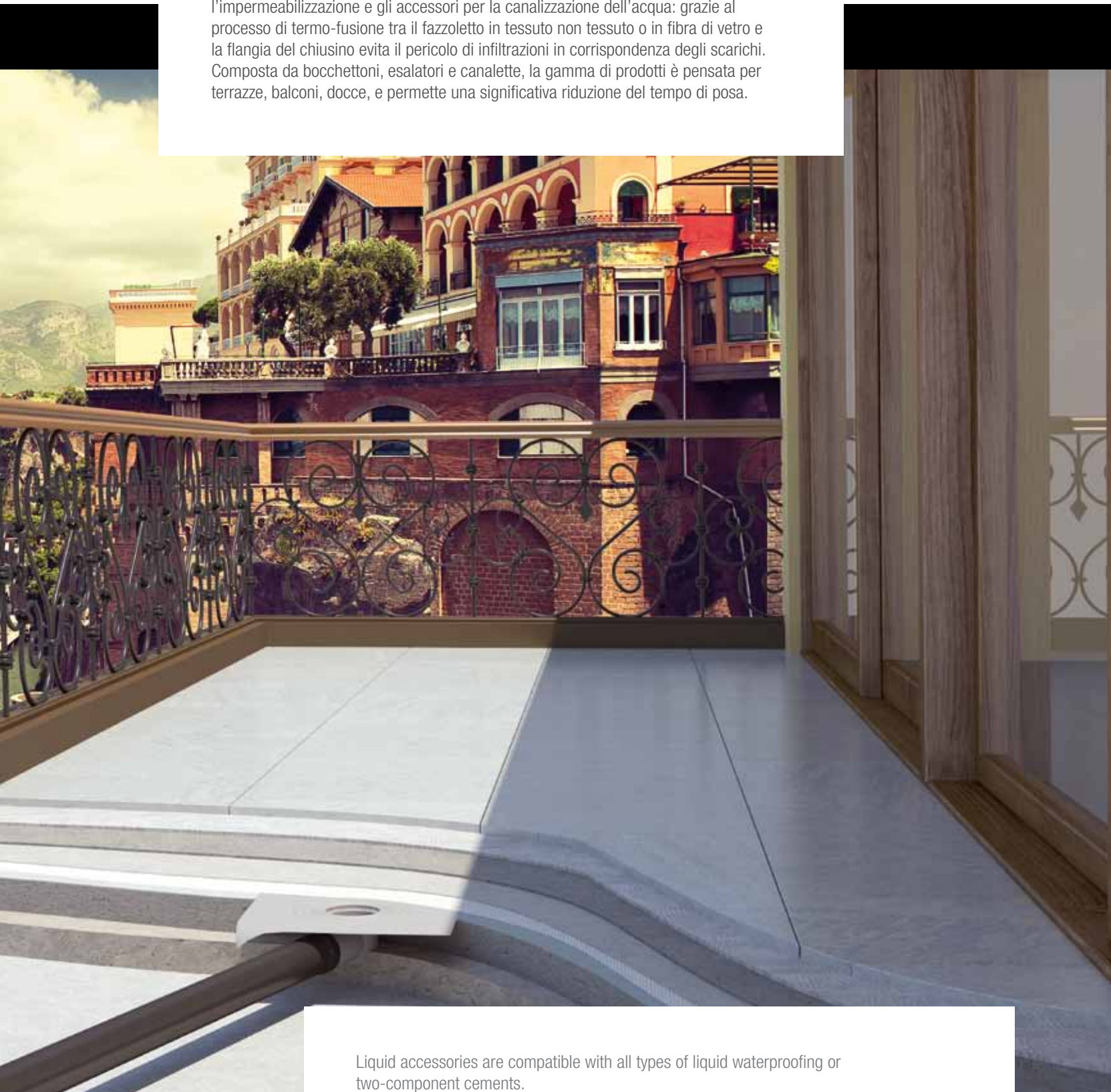

Liquid accessories are compatible with all types of liquid waterproofing or two-component cements.

It's the only drain system that's capable of ensuring absolute continuity between the waterproofing and the water channelling accessories, thanks to the thermo-fusion of the non-woven fabric or fiberglass sheet to the cover flange, thus preventing the risk of leaks around the drains.

Composed by drain outlets and channels, the product range is designed for terraces, balconies and showers, and provides for significantly reduced installation times.

## KIT LIQUID TELESCOPICO VERTICALE E ORIZZONTALE IN TNT

## KIT LIQUID TELESCOPIC WITH NON-WOVEN SHEET

PP



- 1** Griglia in Acciaio Inox  
Stainless Steel Grating
- 2** Telaio in Acciaio Inox  
Stainless Steel Frame
- 3** Valvola anti intrusione Ø 50/75/82/90/100\*  
Anti-intrusion system Ø 50/75/82/90/100\*
- 4** Prolunga Telescopica H90 - H50 - H18  
Telescopic Extension H90 - H50 - H18
- 5** Scanalatura per il deflusso dell'acqua  
Water drainage grooves
- 6** Scanalatura interna "acqua non stop"  
"Non-stop water" internal grooves
- 7** Flangia zigrinata sopra e sotto per migliorare l'ancoraggio  
degli impermeabilizzanti liquidi  
Upper and lower knurled flange to improve the anchoring  
of the liquid waterproofing
- 8** Telo in TNT ad alte prestazioni  
Sheet made from high-performance non-woven fabric
- 9** Chiusino scarico Verticale Ø 50/75/82/90/100  
Vertical drain Ø 50/75/82/90/100



\* La Valvola anti intrusione dello scarico orizzontale è sempre Ø 100

\* The horizontal drain's Anti-intrusion system is always Ø 100

KIT LIQUID TELESCOPICO  
VERTICALE E ORIZZONTALE IN TNT  
KIT LIQUID TELESCOPIC  
WITH NON-WOVEN SHEET



DETTAGLIO  
DETAIL

- 1** Chiusino scarico Orizzontale Ø 50/75/90  
Liquid side drain Ø 50/75/90
- 2** Fondo inclinato anti-ristagno d'acqua  
Sloping bottom to prevent water stagnation



TELO IN TNT AD ALTE  
PRESTAZIONI  
HIGH-PERFORMANCE  
NON-WOVEN SHEET



FLANGIA ZIGRINATA SOPRA E SOTTO  
PER MIGLIORARE L'ANCORAGGIO  
DEGLI IMPERMEABILIZZANTI LIQUIDI  
UPPER AND LOWER KNURLED  
FLANGE TO IMPROVE THE  
ANCHORING OF THE LIQUID  
WATERPROOFING LAYERS



GRIGLIA E TELAIO IN  
ACCIAIO INOX  
STAINLESS STEEL  
GRATING AND FRAME





## LIQUID LATERALE TELESCOPICO TNT

## LIQUID SIDE TELESCOPIC WITH NON-WOVEN SHEET



Disponibile in tre diametri: 50-75-90 mm. Lo scarico orizzontale Liquid con TNT è dotato di un telo in tessuto non tessuto ad alte prestazioni che consente compatibilità soprattutto con gli impermeabilizzanti liquidi a base solvente. La struttura della flangia è provvista di una doppia zigrinatura (sopra e sotto) per migliorare ancor più l'aggancio dei prodotti liquidi; il basamento è inclinato per consentire un miglior deflusso dell'acqua ed evitare ristagni all'interno del chiusino. I gradini presenti all'interno del codolo, evitano l'effetto ventosa della Prolunga, consentendo il deflusso dell'acqua da infiltrazione.

Available in three diameters: 50-75-90 mm. The Liquid side exit drain with non-woven sheet is provided with high performance non-woven material, that allows compatibility especially with solvent base liquid materials. The PP flange is provided with knurled surface on both sides, to improve the adherence of liquid waterproofing materials. Bottom part of the drain is provided with slope, to allow easy water drainage and prevent any stagnation of water inside the drain itself. Small steps on the upper part of the spigot allow dripping of water coming from any upper infiltration.



> POSA  
IN OPERA  
BOCCHETTONE  
SERIE  
"LIQUID"  
> ROOF DRAIN  
"LIQUID"  
INSTALLATION





**KIT LIQUID LATERALE  
TELESCOPICO TNT**  
KIT LIQUID SIDE TELESCOPIC  
WITH NON WOVEN SHEET

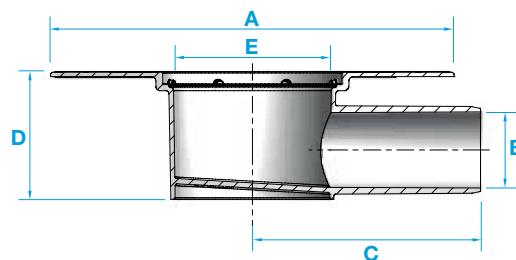

PRODOTTO/PRODUCT				
Codice Code	Misura Size	Pagina listino Price list page		
A400021050	Kit Ø 50 con Prolunga H.90 mm, Valvola anti intrusione Ø 100 e Griglia con telaio inox Kit Ø 50 with Extension element H.90 mm, Anti-intrusion system Ø 100 and inox Grating	4	1	204
A400021075	Kit Ø 75 con Prolunga H.90 mm, Valvola anti intrusione Ø 100 e Griglia con telaio inox Kit Ø 75 with Extension element H.90 mm, Anti-intrusion system Ø 100 and inox Grating	4	1	204
A400021090	Kit Ø 90 con Prolunga H.90 mm, Valvola anti intrusione Ø 100 e Griglia con telaio inox Kit Ø 90 with Extension element H.90 mm, Anti-intrusion system Ø 100 and inox Grating	4	1	204

**BOCCHETTONE LIQUID  
LATERALE TELESCOPICO TNT**  
ROOF DRAIN LIQUID SIDE  
TELESCOPIC WITH NON-  
WOVEN SHEET



PRODOTTO/PRODUCT									
Codice Code	Per tubi For pipes	A	B	C	D	E	Pagina listino Price list page		
A401021050	Ø 50	230	49,5	130	70	89,9	4	18	252
A401021075	Ø 75	230	73,1	130	90	89,9	4	18	252
A401021090	Ø 90	230	88,6	130	120	89,9	4	18	252

## LIQUID VERTICALE TELESCOPICO TNT

## LIQUID STRAIGHT TELESCOPIC WITH NON-WOVEN SHEET



Disponibile in cinque diametri: 50-75-82-90-100 mm. Lo scarico verticale Liquid con TNT è dotato di un tessuto non tessuto ad alte prestazioni che consente compatibilità soprattutto con gli impermeabilizzanti liquidi a base solvente. La struttura della flangia è provvista di una doppia zigrinatura (sopra e sotto) per migliorare ancor più l'aggancio dei prodotti liquidi. I gradini presenti all'interno del codolo evitano l'effetto "ventosa" della Prolunga consentendo il deflusso dell'acqua da infiltrazione.

Available in five diameters: 50-75-82-90-100 mm. The Liquid vertical exit drain with non-woven sheet is provided with high performance non-woven material, that allows compatibility especially with solvent base liquid materials. The PP flange is provided with knurled surface on both sides, to improve the adherence of liquid waterproofing materials. Small steps on the upper part of the spigot allow dripping of water coming from any upper infiltration.





**KIT LIQUID VERTICALE  
TELESCOPICO TNT  
ROOF DRAIN LIQUID  
STRAIGHT TELESCOPIC  
WITH NON-WOVEN SHEET**



PRODOTTO/PRODUCT				
Codice Code	Misura Size	Pagina listino Price list page	 Pz	 Pz
A400011050	Kit Ø 50 con Prolunga H.90 mm, Valvola anti intrusione Ø 50 e Griglia con telaio inox Kit Ø 50 with Extension element H.90 mm, Anti-intrusion system Ø 50 and inox Grating	5	1	108
A400011075	Kit Ø 75 con Prolunga H.90 mm, Valvola anti intrusione Ø 75 e Griglia con telaio inox Kit Ø 75 with Extension element H.90 mm, Anti-intrusion system Ø 75 and inox Grating	5	1	108
A400011082	Kit Ø 82 con Prolunga H.90 mm, Valvola anti intrusione Ø 82 e Griglia con telaio inox Kit Ø 82 with Extension element H.90 mm, Anti-intrusion system Ø 82 and inox Grating	5	1	108
A400011090	Kit Ø 90 con Prolunga H.90 mm, Valvola anti intrusione Ø 90 e Griglia con telaio inox Kit Ø 90 with Extension element H.90 mm, Anti-intrusion system Ø 90 and inox Grating	5	1	108
A400011100	Kit Ø 100 con Prolunga H.90 mm, Valvola anti intrusione Ø100 e Griglia con telaio inox Kit Ø 100 with Extension element H.90 mm, Anti-intrusion system Ø 100 and inox Grating	5	1	108

**BOCCHETTONE LIQUID  
VERTICALE TELESCOPICO TNT  
ROOF DRAIN LIQUID STRAIGHT  
TELESCOPIC WITH NON-WOVEN  
SHEET**



PRODOTTO/PRODUCT								
Codice Code	Per tubi For pipes	A	B	C	D	Pagina listino Price list page	 Pz	 Pz
A401011050	Ø 50	230	42,3	200	42,3	5	9	144
A401011075	Ø 75	230	70,3	200	66,0	5	9	144
A401011082	Ø 82	230	76,1	200	71,8	5	9	144
A401011090	Ø 90	230	84,8	200	80,5	5	9	144
A401011100	Ø 100	230	94,1	200	89,8	5	9	144

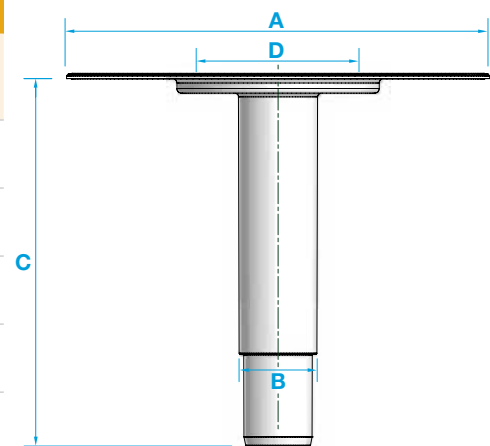

LIQUID  
TELESCOPICO FV

LIQUID TELESCOPIC  
WITH FIBERGLASS  
MESH

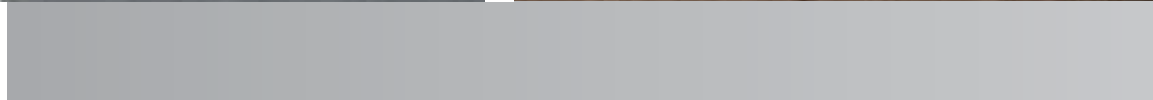
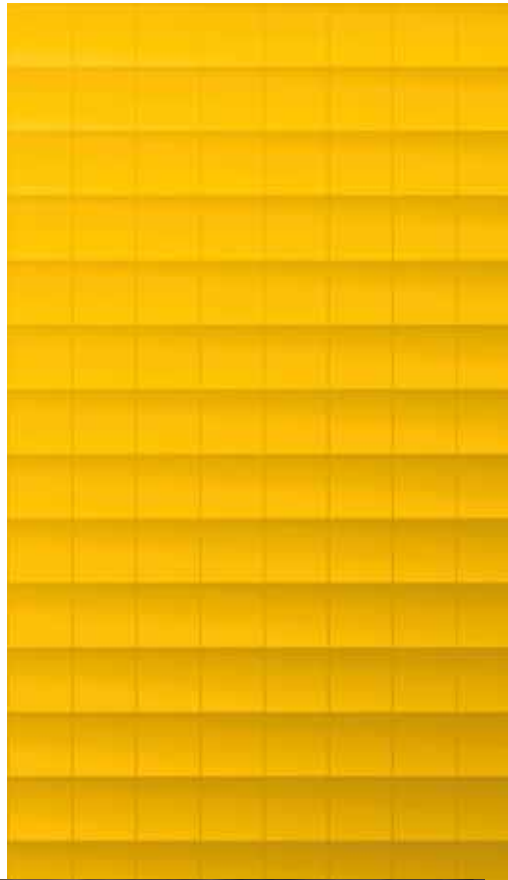

### **Prestazioni e vantaggi saldamente fusi insieme.**

Il punto di forza: la termofusione tra la flangia del bocchettone e il fazzoletto in tessuto non tessuto o fibra di vetro.

La linea Liquid viene fornita in Kit composto da bocchettone di scarico, Prolunga, Valvola anti intrusione, Griglia con telaio in acciaio inox. La struttura della flangia è provvista di una doppia zigrinatura, che migliora l'aggancio con gli impermeabilizzanti liquidi. Nel modello orizzontale, il basamento inclinato garantisce un miglior deflusso dell'acqua, evitando ristagni all'interno del chiusino. Ulteriori vantaggi e prestazioni esclusive:

- i gradini all'interno del codolo evitano l'effetto ventosa della Prolunga consentendo il deflusso dell'acqua da infiltrazione,
  - la Prolunga intagliabile permette la posa anche della sola colla e piastrelle a ridosso dell'impermeabilizzazione,
  - La Valvola anti intrusione evita l'ingresso di insetti che possono essere presenti nelle tubature e limita gli odori da reflusso.
- E il tutto è ispezionabile attraverso la griglia in acciaio inox.

### **Performance and advantages, fused firmly together.**

The strength: thermal fusion between the flange of the drain outlet and the non-woven fabric or fiberglass sheet.

The Liquid line is furnished in a Kit comprised of a drain outlet, an extension, an anti-odour plug, and a stainless steel grille and frame. The flange's structure features double knurling, which ensures improved coupling using waterproofing liquids and two-component cements. In the horizontal model, the inclined base ensures better water drainage, thus preventing any water from remaining inside the cover.

Additional exclusive performance advantages:

- the steps inside of the shank prevent the extension from creating a suction effect, thus allowing for any water infiltrations to drain off,
  - the special extension also allows for glue and tiles to be installed on top of the waterproofing,
  - the anti-odour plug prevents the backflow of any odours, as well as the entry of any insects that may be present inside the pipes.
- The entire system can be inspected through the stainless steel grille.



## KIT LIQUID TELESCOPICO VERTICALE E ORIZZONTALE FV

## KIT LIQUID TELESCOPIC WITH FIBERGLASS MESH

PP



- 1** Griglia in Acciaio Inox  
Stainless Steel Grating
- 2** Telaio in Acciaio Inox  
Stainless Steel Frame
- 3** Valvola anti intrusione Ø 50/75/82/90/100\*  
Anti-intrusion system Ø 50/75/82/90/100\*
- 4** Prolunga Telescopica H90 - H50 - H18  
Telescopic Extension H90 - H50 - H18
- 5** Scanalatura per il deflusso dell'acqua  
Water drainage grooves
- 6** Scanalatura interna "acqua non stop"  
"Non-stop water" internal grooves
- 7** Flangia zigrinata sopra e sotto per migliorare  
l'ancoraggio degli impermeabilizzanti liquidi  
Upper and lower knurled flange to improve the  
anchoring of the liquid waterproofing layers
- 8** Rete in FV certificata ad alte prestazioni  
High-performance certified Fiberglass mesh
- 9** Chiusino scarico Verticale Ø 50/75/82/90/100  
Vertical drain cover Ø 50/75/82/90/100



\* La Valvola anti intrusione dello  
scarico orizzontale è sempre Ø 100  
\* The horizontal drain's Anti-intrusion  
system is always Ø 100



KIT LIQUID TELESCOPICO  
VERTICALE E ORIZZONTALE FV  
KIT LIQUID TELESCOPIC  
WITH FIBERGLASS MESH



DETTAGLIO  
DETAIL

- 1** Chiusino scarico orizzontale Ø 50 / 75 / 90  
Liquid side drain Ø 50 / 75 / 90
- 2** Fondo inclinato anti ristagno d'acqua  
Sloping bottom to prevent water stagnation

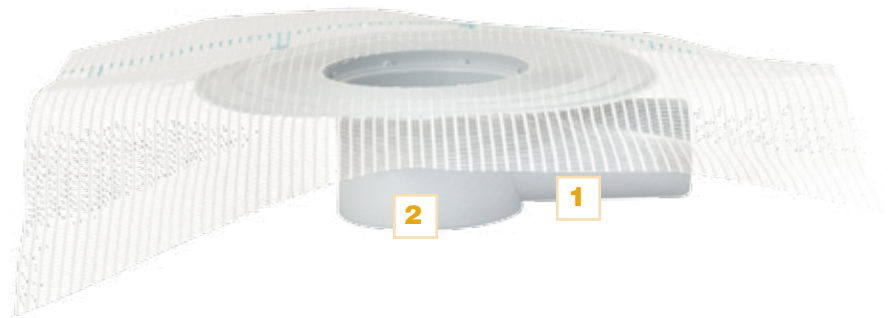

TELO FV AD ALTE  
PRESTAZIONI  
HIGH-PERFORMANCE  
CERTIFIED FIBERGLASS  
MESH



SCANALATURA PER IL  
DEFLUSSO DELL'ACQUA  
WATER DRAINAGE  
GROOVES



GRIGLIA E TELAIO IN  
ACCIAIO INOX  
STAINLESS STEEL  
GRATING AND FRAME



## LIQUID LATERALE TELESCOPICO FV

## LIQUID SIDE TELESCOPIC WITH FIBERGLASS MESH

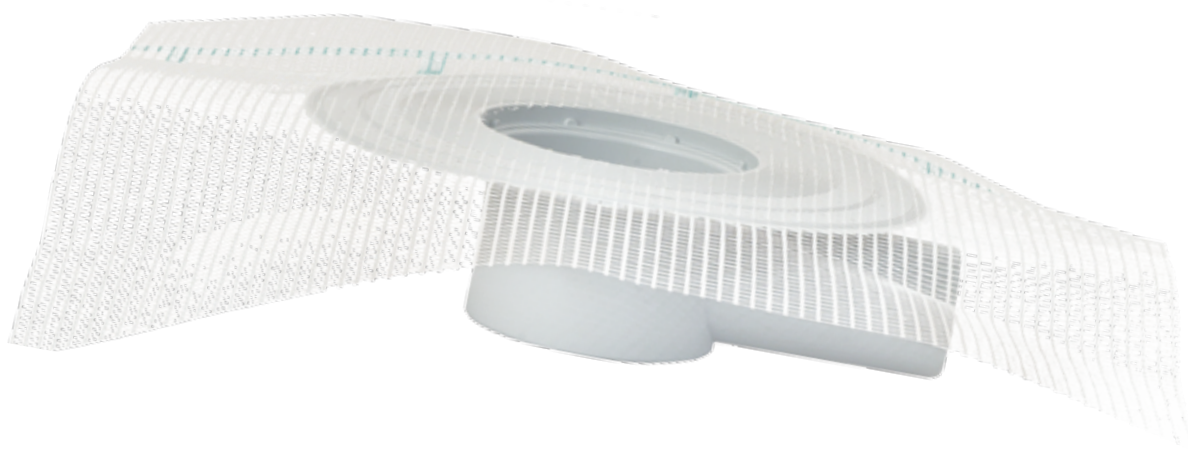

Disponibile in tre diametri: 50-75-90 mm. Lo scarico orizzontale Liquid con FV è dotato di un rete in fibra di vetro certificata che consente compatibilità soprattutto con gli impermeabilizzanti liquidi a base acqua. La struttura della flangia è provvista di una doppia zigrinatura (sopra e sotto) per migliorare ancor più l'aggancio con i prodotti liquidi; il basamento è inclinato per consentire un miglior deflusso dell'acqua ed evitare ristagni all'interno del chiusino. I gradini presenti all'interno del codolo evitano l'effetto ventosa della Prolunga consentendo il deflusso dell'acqua da infiltrazione.

Available in three diameters: 50-75-90 mm. The Liquid side exit drain with fiberglass mesh is provided of certified fiberglass mesh, that allows compatibility especially with water base liquid waterproofing materials. The PP flange is provided with knurled surface on both sides, to improve the adherence of liquid insulating materials. Bottom part of the drain is provided with slope, to allow easy water drainage and prevent any stagnation of water inside the drain itself. Small steps on the upper part of the spigot allow dripping of water coming from any upper infiltration.





KIT LIQUID LATERALE  
TELESCOPICO FV  
KIT LIQUID SIDE TELESCOPIC  
WITH FIBERGLASS MESH

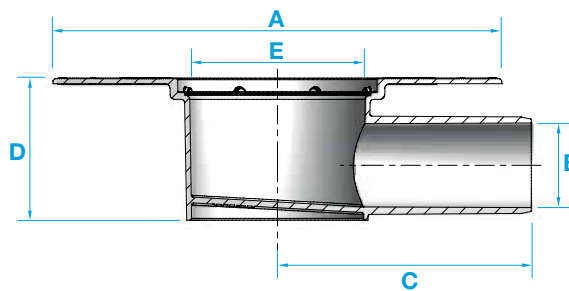

PRODOTTO/PRODUCT				
Codice Code	Misura Size	Pagina listino Price list page	 Pz	 Pz
A400022050	Kit Ø 50 con Prolunga H.90 mm, Valvola anti intrusione Ø 100 e Griglia con telaio inox Kit Ø 50 with Extension element H.90 mm, Anti-intrusion system Ø 100 and inox Grating	6	1	204
A400022075	Kit Ø 75 con Prolunga H.90 mm, Valvola anti intrusione Ø 100 e Griglia con telaio inox Kit Ø 75 with Extension element H.90 mm, Anti-intrusion system Ø 100 and inox Grating	6	1	204
A400022090	Kit Ø 90 con Prolunga H.90 mm, Valvola anti intrusione Ø 100 e Griglia con telaio inox Kit Ø 90 with Extension element H.90 mm, Anti-intrusion system Ø 100 and inox Grating	6	1	204

BOCCHETTONE LIQUID  
LATERALE TELESCOPICO FV  
ROOF DRAIN LIQUID  
SIDE TELESCOPIC WITH  
FIBERGLASS MESH



PRODOTTO/PRODUCT									
Codice Code	Per tubi For pipes	A	B	C	D	E	Pagina listino Price list page	 Pz	 Pz
A401022050	Ø 50	230	49,5	130	70	89,9	6	18	252
A401022075	Ø 75	230	73,1	130	90	89,9	6	18	252
A401022090	Ø 90	230	88,6	130	120	89,9	6	18	252

## LIQUID VERTICALE TELESCOPICO FV

## LIQUID STRAIGHT TELESCOPIC WITH FIBERGLASS MESH



Disponibile in cinque diametri: 50-75-82-90-100 mm. Lo scarico verticale Liquid con FV è dotato di una rete in fibra di vetro certificata che consente compatibilità soprattutto con gli impermeabilizzanti liquidi a base acqua. La struttura della flangia è provvista di una doppia zigrinatura (sopra e sotto) per migliorare ancor più l'aggancio dei prodotti liquidi. I gradini presenti all'interno del codolo evitano l'effetto "ventosa" della Prolunga consentendo il deflusso dell'acqua da infiltrazione.

Available in five diameters: 50-75-82-90-100 mm. The Liquid vertical exit drain with fiberglass mesh is provided of certified fiberglass mesh, that allows compatibility especially with water base liquid waterproofing materials. The PP flange is provided of knurled surface on both sides, to improve the adherence of liquid waterproofing materials. Small steps on the upper part of the spigot allow dripping of water coming from any upper infiltration.





KIT LIQUID VERTICALE  
TELESCOPICO FV  
KIT LIQUID STRAIGHT  
TELESCOPIC WITH  
FIBERGLASS MESH



PRODOTTO/PRODUCT				
Codice Code	Misura Size	Pagina listino Price list page	 Pz	 Pz
A400012050	Kit Ø 50 con Prolunga H.90 mm, Valvola anti intrusione Ø 50 e Griglia con telaio inox Kit Ø 50 with Extension element H.90 mm, Anti-intrusion system Ø 50 and inox Grating	7	1	108
A400012075	Kit Ø 75 con Prolunga H.90 mm, Valvola anti intrusione Ø 75 e Griglia con telaio inox Kit Ø 75 with Extension element H.90 mm, Anti-intrusion system Ø 75 and inox Grating	7	1	108
A400012082	Kit Ø 82 con Prolunga H.90 mm, Valvola anti intrusione Ø 82 e Griglia con telaio inox Kit Ø 82 with Extension element H.90 mm, Anti-intrusion system Ø 82 and inox Grating	7	1	108
A400012090	Kit Ø 90 con Prolunga H.90 mm, Valvola anti intrusione Ø 90 e Griglia con telaio inox Kit Ø 90 with Extension element H.90 mm, Anti-intrusion system Ø 90 and inox Grating	7	1	108
A400012100	Kit Ø 100 con Prolunga H.90 mm, Valvola anti intrusione Ø 100 e Griglia con telaio inox Kit Ø 100 with Extension element H.90 mm, Anti-intrusion system Ø 100 and inox Grating	7	1	108

BOCCHETTONE LIQUID VERTICALE  
TELESCOPICO FV  
ROOF DRAIN LIQUID  
STRAIGHT TELESCOPIC  
WITH FIBERGLASS MESH

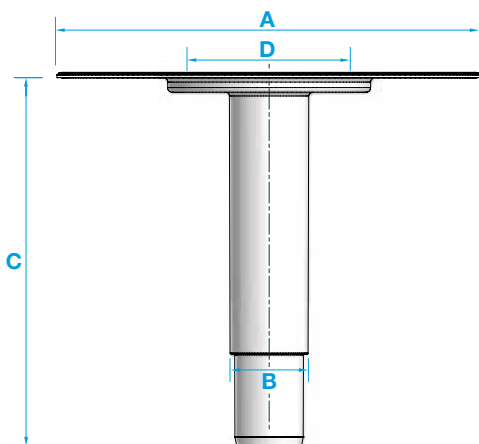

PRODOTTO/PRODUCT								
Codice Code	Per tubi For pipes	A	B	C	D	Pagina listino Price list page	 Pz	 Pz
A401012050	Ø 50	230	42,3	200	42,3	7	9	144
A401012075	Ø 75	230	70,3	200	66,0	7	9	144
A401012082	Ø 82	230	76,1	200	71,8	7	9	144
A401012090	Ø 90	230	84,8	200	80,5	7	9	144
A401012100	Ø 100	230	94,1	200	89,8	7	9	144

## ACCESSORI

## ACCESSORIES

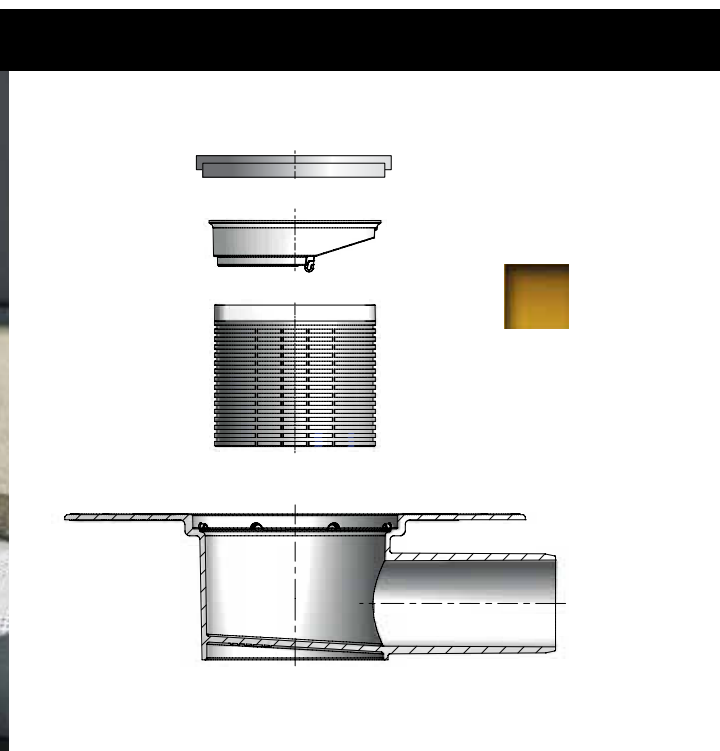

### GRIGLIA CON TELAIO

### GRATING WITH FRAME

Costruita in acciaio inox è adattabile a tutti gli scarichi e va inserita sopra la Prolunga.

Made in stainless steel, it's suitable to all our drains and used on top of the Extension Element.

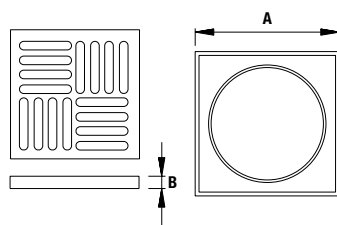

INOX

### PROLUNGA H90

### EXTENSION ELEMENT H90

Da posizionarsi sopra lo scarico, permette di compensare pacchetti impermeabili di spessori variabili. La Prolunga è infatti facilmente intagliabile per essere adattata all'altezza richiesta dal pacchetto isolante.

To be placed on top of the floor drain, it allows the thickness' compensation of the insulation system. The Extension Element in fact can be easily cut to reach the desired highness.

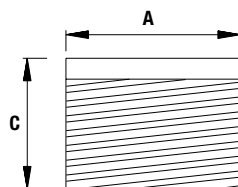

PP

## PROLUNGA H50 EXTENSION ELEMENT H50

Da posizionarsi sopra lo scarico, permette di compensare pacchetti impermeabili di spessori variabili. La Prolunga è infatti facilmente intagliabile per essere adattata all'altezza richiesta dal pacchetto isolante.

To be placed on top of the floor drain, it allows the thickness' compensation of the insulation system. The Extension Element in fact can be easily cut to reach the desired highness.

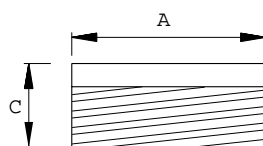

PP

## PROLUNGA H18 EXTENSION ELEMENT H18

Adatta alle applicazioni senza pacchetto isolante o comunque in tutti quei casi dove si posano direttamente colla e piastrelle sopra il piano del bocchettone.

Suitable for applications without insulation or in all those cases where adhesive and tiles are laid directly on the drain hole surface.

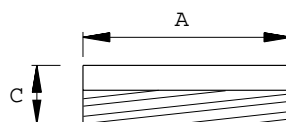

PP



## VALVOLA ANTI INTRUSIONE ANTI-INTRUSION SYSTEM

Disponibile in 5 diametri, va inserito sopra la Prolunga nel caso di scarico orizzontale o direttamente nel codolo solo nel caso di scarico verticale.

Available in 5 diameters, it has to be inserted inside the Extension Element when using a side exit drain, or directly inside the spigot of the vertical drain.



PP

PRODOTTO/PRODUCT								
Codice Code	Descrizione Description	Ø	A	B	C	Pagina listino Price list page		
A430100100	Griglia con telaio Grating with frame	-	104	5	-	14	1	-
A420100078	Prolunga H90 Extension Element H90	-	99	-	88	14	1	-
A420100037	Prolunga H50 Extension Element H50	-	99	-	48	14	1	-
A420100018	Prolunga H18 Extension Element H18	-	99	-	17,5	14	1	-
A410010050	Valvola anti intrusione Anti-intrusion system	50	-	-	-	15	1	-
A410010075	Valvola anti intrusione Anti-intrusion system	75	-	-	-	15	1	-
A410010082	Valvola anti intrusione Anti-intrusion system	82	-	-	-	15	1	-
A410010090	Valvola anti intrusione Anti-intrusion system	90	-	-	-	15	1	-
A410010100	Valvola anti intrusione Anti-intrusion system	100	-	-	-	15	1	-

## ESALATORE PER LE IMPERMEABILIZZAZIONI LIQUIDE

## VENT PIPE FOR LIQUID WATERPROOFING



### La giusta via di uscita

L'Esalatore Liquid rappresenta la giusta via di uscita per qualsiasi tipo di esalazione, vapore e condensa, e la soluzione ai gravi problemi di infiltrazioni d'acqua causate dal rigonfiamento dello strato impermeabile liquido, facilmente fessurabile con i cambi climatici.

Con il fazzoletto in TNT ad alte prestazioni elastiche, fuso meccanicamente alla flangia dell'esalatore, viene assicurata la saldatura in un unico strato tra il prodotto e l'armatura, che crea una impermeabilizzazione continua ed oltremodo efficace.

L'Esalatore Liquid è compatibile con tutti i prodotti impermeabilizzanti liquidi e cementi bicomponenti presenti sul mercato.

> POSA  
IN OPERA  
ESALATORE  
LIQUID  
> VENT PIPE  
INSTALLATION







#### **The right exit**

The Liquid Vent is the right accessory for the exit of steam and condensation, and the solution for serious issues resulting from water infiltration caused by the swelling of the liquid waterproof layer, which can easily crack with changes in weather conditions.

The TNT high-performance elastic sheet or the fiberglass mesh, which are mechanically bonded to the vent's flange, ensure single layer welding between the product and the sheet, thus creating continuous and extremely effective waterproofing.

The Liquid Vent is compatible with all available liquid waterproofing products and bicomponent cements in the market.



PP



## VANTAGGI:

- Impermeabilizzazione continua
- Tecnologia innovativa
- Diminuzione del rischio di infiltrazioni
- Velocità di posa

## ADVANTAGES:

- Continuous waterproofing
- Innovative technology
- Less infiltration leaks
- Quick installation

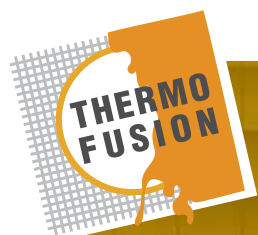

SISTEMA DI TERMOFUSIONE TRA FAZZOLETTO E FLANGIA DELL'ESALATORE.

THERMOFUSION SYSTEM BETWEEN VENT AND TNT.



CUPOLA  
CUP



- 1** Cupola  
Cup
- 2** Esalatore  
Vent Pipe
- 3** Flangia con parte inferiore  
corredata da convogliatori di  
vapore  
Flange with embossed  
points for vapor passage
- 4** TNT ad alte prestazioni  
High-performance textile sheet

FLANGIA CON PARTE  
INFERIORE CORREDATA  
DA CONVOGLIATORI DI  
VAPORE  
FLANGE WITH  
EMBOSSED POINTS  
FOR VAPOR PASSAGE



TNT AD ALTE  
PRESTAZIONI  
HIGH-PERFORMANCE  
TEXTILE SHEET

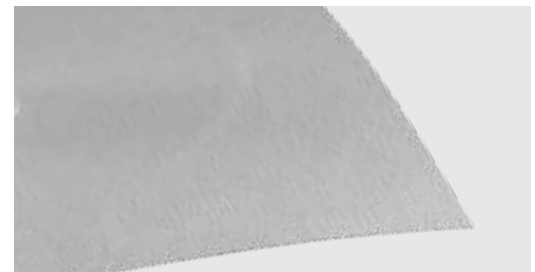

PRODOTTO/PRODUCT						
Codice Code	Tipo Type	H	Esterno External	Pagina listino Price list page	 Pz	 Pz
D021200075	TNT	200	Ø 75	8	1	-

BOCCHETTONI  
ANGOLARI LIQUID  
PER POGGIOLI

LIQUID ANGULAR  
DRAIN FOR  
BALCONIES



Complete compatibility with all types of liquid membranes, two-component and single-component cements and plastivo products. Thanks to the thermo-fusion of the non-woven fabric or fiberglass sheet to the cover flange, this one-of-a-kind system is capable of preventing leaks around the drain outlets. Thanks to their extreme ease of installation and complete compatibility with the waterproofing layer, these angular drain outlets are perfect for any application.



Compatibilità totale con tutte le tipologie di guaine liquide, cementi bicomponenti, monocomponenti e plastivi. Grazie alla termofusione del tessuto-non-tessuto e della fibra di vetro alla flangia, si prevengono infiltrazioni d'acqua e si garantisce durata illimitata. L'estrema facilità di posa rendono questi bocchettoni angolari la scelta perfetta in ogni situazione applicativa.

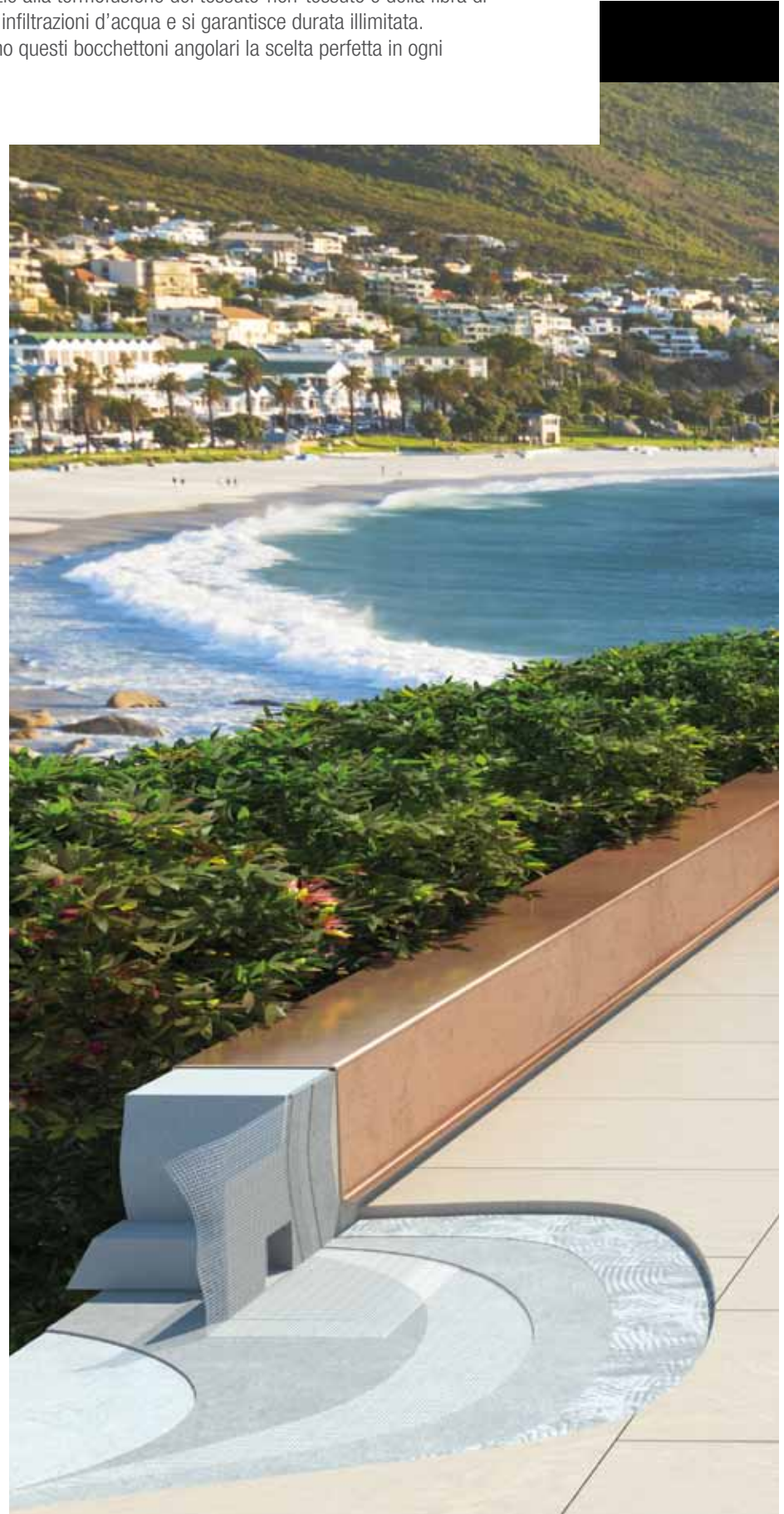

## BOCCHETTONI ANGOLARI LIQUID PER POGGIOLI

LIQUID ANGULAR  
DRAIN FOR  
BALCONIES

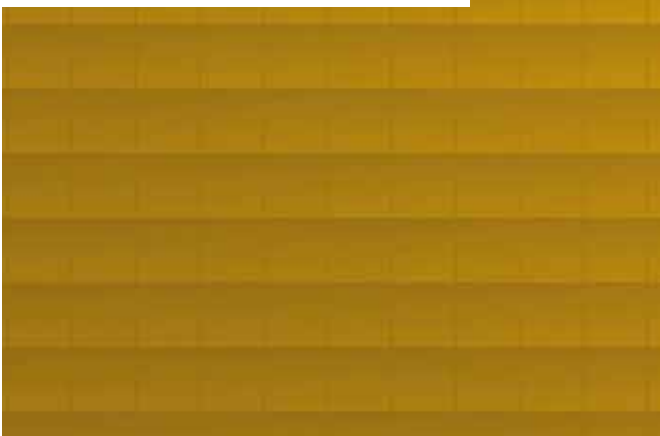

BOCCHETTONE ANGOLARE  
LIQUID PER POGGIOLI FV  
ANGULAR LIQUID DRAIN  
FOR BALCONIES WITH  
FIBERGLASS MESH

TPE



### PRODOTTO/PRODUCT

Codice Code	Misura Size	Pagina listino Price list page	Pz 	Pz 
A043347121	Lunghezza / Lenght 347 Sezione / Section 57x48 Avorio / Ivory	8	1	-
A043347123	Lunghezza / Lenght 347 Sezione / Section 57x48 Rame / Copper	8	1	-



> POSA IN OPERA  
DEL BOCCHETTONE  
ANGOLARE LIQUID PER  
POGGIOLI  
> INSTALLATION OF  
LIQUID ANGULAR DRAIN  
FOR BALCONIES



BOCCHETTONE ANGOLARE  
LIQUID PER POGGIOLI TNT  
ANGULAR LIQUID DRAIN FOR  
BALCONIES WITH  
NON-WOVEN SHEET



PRODOTTO/PRODUCT				
Codice Code	Misura Size	Pagina listino Price list page	 Pz	 Pz
A043347131	Lunghezza / Length 347 Sezione / Section 57x48 Avorio / Ivory	8	1	-
A043347133	Lunghezza / Length 347 Sezione / Section 57x48 Rame / Copper	8	1	-

## CANALETTE DOCCIA

## SHOWER CHANNEL



It's a product line that's been designed according to the latest architectural and design trends, which favour infinity edge gutters rather than traditional shower trays. The linear gutter for shower drains is available in either polypropylene or stainless steel, and comes complete with a stainless steel grille, an anti-odour trap, and a non-woven fabric installation Kit that guarantees compatibility with all the waterproofing liquids used for installing showers (liquid membranes, two-component and one-component cements and plastivo products).



Una linea pensata in base alle più attuali tendenze architettoniche e di design, che privilegiano le canalette a sfioro rispetto al tradizionale piatto doccia.

La canaletta lineare per scarichi doccia è disponibile sia in polipropilene sia in acciaio inox, ed è corredata da griglia in acciaio inox, telo in tessuto non tessuto, sifone valvola anti intrusione e Kit di fissaggio.

Compatibilità garantita con tutti gli impermeabilizzanti liquidi utilizzati nella fase di posa delle docce (guaine liquide, cementi bicomponenti, monocomponenti e plastivi).

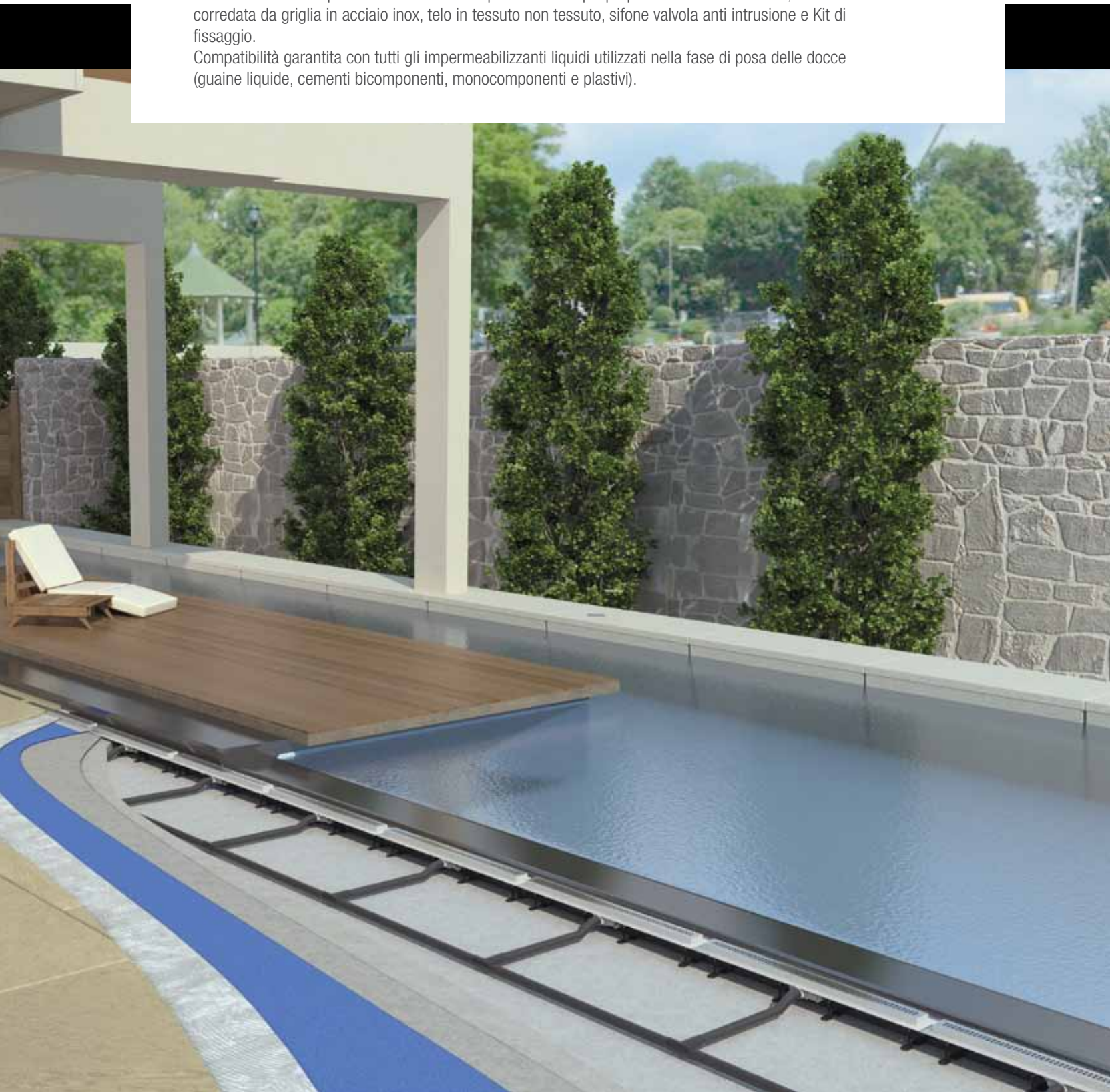

## CANALETTA DOCCIA "LIQUID" IN ACCIAIO INOX

## STAINLESS STEEL "LIQUID" SHOWER CHANNEL



INOX



L'estetica funzionale unita all'acciaio, conferiscono alla canaletta Liquid affidabilità ed innovazione. Disponibile nel diametro 40mm e con tre diverse soluzioni estetiche, la canaletta Liquid offre un generoso telo in TNT ad alte prestazioni da applicare intorno al perimetro in modo da consentire una posa sicura e garantire un'impermeabilizzazione continua in ogni situazione. La canaletta Liquid dispone di due guide poste al di sotto del basamento, che garantiscono una perfetta linearità.

The aesthetic and functional properties of steel make the Liquid channel reliable and innovative. Available in diameter 40 mm and with three different aesthetic design solutions, Liquid channel offers a high performance non-woven sheet to be applied around the perimeter for secure installation and to ensure successful waterproofing in every situation. Liquid channel has two runners located under the base, ensuring perfect linearity.

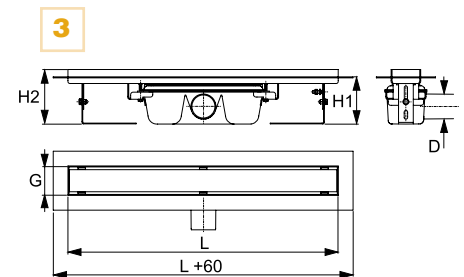
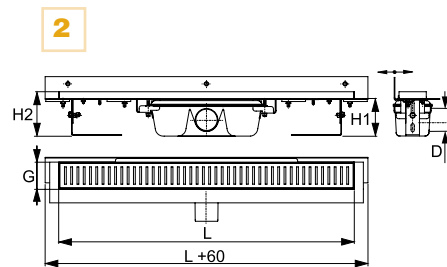
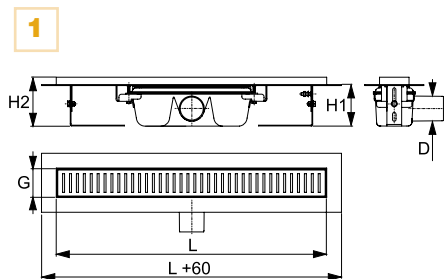



### IL KIT CONTIENE KIT CONTAINS

- 1** Canaletta in acciaio Inox  
Stainless steel channel
- 2** Bandella in TNT perimetrale  
Butyl-textile tape
- 3** Sifone antidore  
Anti-odor system
- 4** Kit di fissaggio  
Anchor kit





**1** CANALETTA INOX  
STAINLESS STEEL  
SHOWER CHANNEL



PRODOTTO/PRODUCT										
Codice Code	Descrizione Description	L	G	D	H1	H2	Pagina listino Price list page			
I051010075	Kit Canaletta doccia sifonata in acciaio Inox 750 mm Kit Stainless steel shower drain channel 750 mm	750	60	∅ 40	55	70-96	9	1	-	
I051010085	Kit Canaletta doccia sifonata in acciaio Inox 850 mm Kit Stainless steel shower drain channel 850 mm	850	60	∅ 40	55	70-96	9	1	-	
I051010095	Kit Canaletta doccia sifonata in acciaio Inox 950 mm Kit Stainless steel shower drain channel 950 mm	950	60	∅ 40	55	70-96	9	1	-	



**2** CANALETTA INOX  
ANGOLARE  
STAINLESS STEEL  
ANGULAR SHOWER  
CHANNEL

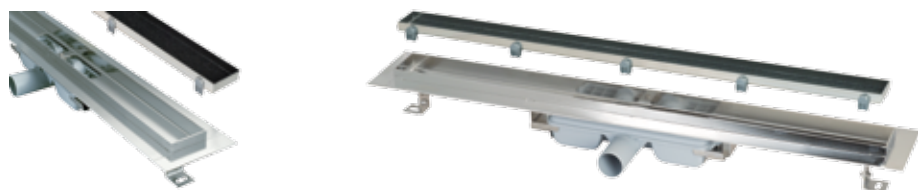

PRODOTTO/PRODUCT										
Codice Code	Descrizione Description	L	G	D	H1	H2	Pagina listino Price list page			
I051020075	Kit Canaletta doccia angolare sifonata in acciaio Inox 750 mm Kit Stainless steel angular shower drain channel 750 mm	750	60	∅ 40	55	70-96	9	1	-	
I051020085	Kit Canaletta doccia angolare sifonata in acciaio Inox 850 mm Kit Stainless steel angular shower drain channel 850 mm	850	60	∅ 40	55	70-96	9	1	-	
I051020095	Kit Canaletta doccia angolare sifonata in acciaio Inox 950 mm Kit Stainless steel angular shower drain channel 950 mm	950	60	∅ 40	55	70-96	9	1	-	

**3** CANALETTA INOX  
CON VASCHETTA  
STAINLESS STEEL  
SHOWER CHANNEL  
WITH TRAY



PRODOTTO/PRODUCT										
Codice Code	Descrizione Description	L	G	D	H1	H2	Pagina listino Price list page			
I051030075	Kit Canaletta doccia sifonata in acciaio Inox con vaschetta 750 mm Kit Stainless steel shower drain channel with tray 750 mm	750	60	∅ 40	65	80-106	9	1	-	
I051030085	Kit Canaletta doccia sifonata in acciaio Inox con vaschetta 850 mm Kit Stainless steel shower drain channel with tray 850 mm	850	60	∅ 40	65	80-106	9	1	-	
I051030095	Kit Canaletta doccia sifonata in acciaio Inox con vaschetta 950 mm Kit Stainless steel shower drain channel with tray 950 mm	950	60	∅ 40	65	80-106	9	1	-	



## GRIGLIA PER CANALETTA "LIQUID" IN ACCIAIO INOX

## GRATING FOR STAINLESS STEEL "LIQUID" CHANNEL

INOX

HOPE



PURE



LINE



> POSA  
IN OPERA  
CANALETTA  
SERIE  
"LIQUID"  
> CHANNEL  
"LIQUID"  
INSTALLATION



### PRODOTTO/PRODUCT

Codice Code	Descrizione Description	Misura Size	Pagina listino Price list page		
I061703075	Griglia canaletta doccia - modello Hope Grating for stainless steel channel - Hope type	L750	10	1	-
I061703085	Griglia canaletta doccia - modello Hope Grating for stainless steel channel - Hope type	L850	10	1	-
I061703095	Griglia canaletta doccia - modello Hope Grating for stainless steel channel - Hope type	L950	10		

### PRODOTTO/PRODUCT

Codice Code	Descrizione Description	Misura Size	Pagina listino Price list page		
I061702075	Griglia canaletta doccia - modello Pure Grating for stainless steel channel - Pure type	L750	10	1	-
I061702085	Griglia canaletta doccia - modello Pure Grating for stainless steel channel - Pure type	L850	10	1	-
I061702095	Griglia canaletta doccia - modello Pure Grating for stainless steel channel - Pure type	L950	10	1	-

### PRODOTTO/PRODUCT

Codice Code	Descrizione Description	Misura Size	Pagina listino Price list page		
I061701075	Griglia canaletta doccia - modello Line Grating for stainless steel channel - Line type	L750	10	1	-
I061701085	Griglia canaletta doccia - modello Line Grating for stainless steel channel - Line type	L850	10	1	-
I061701095	Griglia canaletta doccia - modello Line Grating for stainless steel channel - Line type	L950	10	1	-

## CANALETTA DOCCIA "LIQUID" IN PP

### "LIQUID" SHOWER CHANNEL PP



### KIT CANALETTA "LIQUID" IN POLIPROPILENE KIT "LIQUID" CHANNEL PP

Altezza costruttiva ridotta: soltanto 6,2 cm  
 Facilità di pulizia fino al tubo di scarico (Ø 40 mm)  
 Elevata resistenza agli agenti chimici  
 Eccellente compatibilità con il pacchetto impermeabile,  
 grazie al TNT in dotazione  
 Sifone antiodore  
 Drenaggio 30 l/min

Low height of only 6.2 cm  
 Easy demountability and cleanability up to pipe (Ø 40 mm)  
 High resistance to chemicals  
 Secure connection to the waterproofing  
 Anti-odour system  
 Flow rate 30 l/min

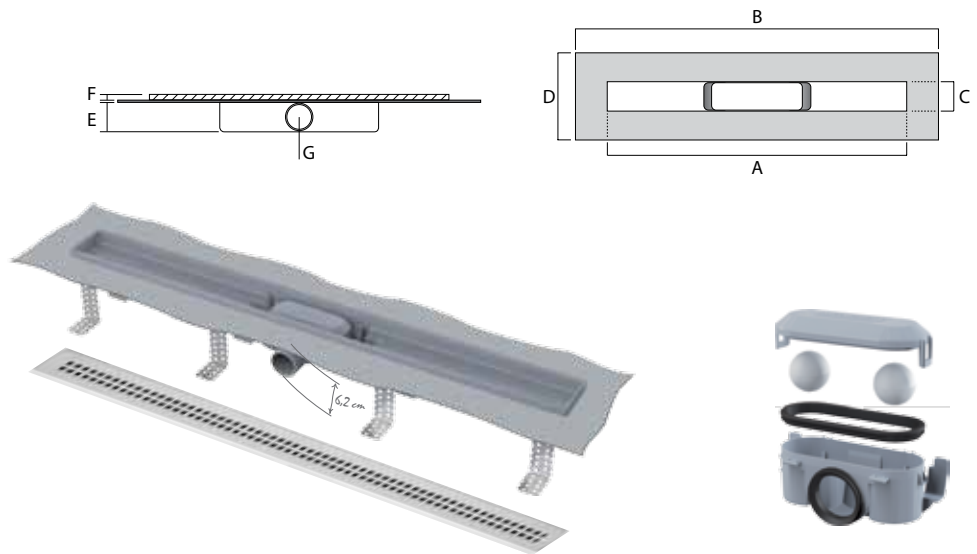

PRODOTTO/PRODUCT											
Codice Code	Descrizione Description	A	B	C	D	E	F	G	Pagina listino Price list page	Pz	Pz
1051100075	Kit Canaletta Doccia con TNT Shower Channel Kit with non woven sheet	750	810	62	121	62	12	40	11	1	-
1051100085	Kit Canaletta Doccia con TNT Shower Channel Kit with non woven sheet	850	910	62	121	62	12	40	11	1	-
1051100095	Kit Canaletta Doccia con TNT Shower Channel Kit with non woven sheet	950	1010	62	121	62	12	40	11	1	-

### IL KIT CONTIENE KIT CONTAINS

Canaletta in PP  
 PP channel

Griglia (acciaio Inox)  
 Stainless steel grating

Bandella in TNT perimetrale  
 Butyl-textile tape

Sifone antiodore  
 Anti-odor system

Kit di fissaggio (bulloni, pioli, 8 piedini)  
 Anchor Kit (screws, dowels, 8 legs)





# Plastic+

Group



Concept & Art Direction: Dnart srl - Firenze  
3D real vision design: Dnart srl - Firenze  
Communication design: Dnart srl - Firenze  
Print typography: Tipografia Toffanin - Padova

Nessuna parte di questa brochure può essere riprodotta in qualunque forma senza autorizzazione di Eterno Ivica s.r.l.  
All right reserved. No part of this publication may be reproduced in any form without prior permission from Eterno Ivica s.r.l.



ETERNO IVICA SRL

Via Austria, 25/E  
Z.I. SUD 35127 PADOVA - ITALY

T. ITALIA +39 049 8530101  
T. EXPORT +39 049 8530102  
FAX +39 049 8530111

[eternoivica@eternoivica.com](mailto:eternoivica@eternoivica.com)



**eternoivica**  
WWW.ETERNOIVICA.COM